



Lewisville Town Council
Regular Meeting Agenda
November 14, 2024 – 6:00 PM
Lewisville Town Hall 1st Floor Council Chambers
6510 Shallowford Road

1. Call to Order:

- A. Roll Call
- B. Invocation – Council Member Jane Welch
- C. Pledge of Allegiance – Council Member Ivan Huffman
- D. Adoption of Agenda

2. Consent Agenda

- A. Resolution 2024-054– Financial statements for three months ended September 30, 2024 ([Attachment #1](#))
- B. Approval of Agenda Briefing Minutes – October 3, 2024 ([Attachment #2](#))
- C. Approval of Regular Meeting Minutes – October 10, 2024 ([Attachment #3](#))
- D. 2025 Meeting Schedule, revised ([Attachment #4](#))

3. Introductions, Recognitions, Presentations and/or Proclamations

- A. Recognitions
 - i. I’m One of the Reasons Lewisville is a Great Place to Live
 - a. Karen Swart
- B. Presentations
 - i. Sheriff’s Office
 - ii. June 30, 2024 Audit Report – Monty Pendry, Gibson & Company PA

4. Public Forum

- A. Residents should register with the Town Clerk and limit their comments to three (3) minutes.
- B. Written comments are also available.

5. Technical Review

- A. Resolution 2025-055 – Technical review for compliance – Shady Brook Acres subdivision ([Attachment #5](#))

6. New Business

- A. Resolution 2024-057 – Technology Policy ([Attachment #6](#))
- B. Resolution 2024-058 – Fall roadway maintenance contract – \$86,952 ([Attachment #7](#))
- C. Resolution 2024-059 – Facility Use Exemption – Lewisville United Methodist Church Preschool ([Attachment #8](#))

7. Administrative Reports

- A. Upcoming events and closings
 - i. Shallowford Square art call deadline, November 27
 - ii. Town offices closed, November 28-29
 - iii. MAWCC mural art call deadline, December 1
 - iv. Holiday Open House, December 6, 4:30-6:30 PM, MAWCC
 - v. Christmas Tree Lighting, December 6, 7 PM
 - vi. Christmas Parade, December 8, 3 PM
 - vii. Blood Drive, December 11, 1-6 PM
 - viii. How the Grinch Stole Christmas, December 13, 6 PM, MAWCC

B. Approvals at the Briefing and Action Meeting on November 7, 2024

- i. Resolution 2024-056 - NCDOT agreement for Great Wagon Road (TIP U-5536) additional work - \$556,375
- ii. Ordinance 2024-038 – Amending Budget Ordinance 2024-001 – Public Works building operating expenses - \$14,789

8. For the Good of the Order

A. Public Comments

- i. Residents should limit their comments to three (3) minutes.
- ii. Written comment forms are also available.

B. Council Comments

- i. Potential called meeting - Mayor Horn

9. Adjournment



**RESOLUTION 2024-054 OF THE LEWISVILLE TOWN COUNCIL
ACCEPTANCE AND APPROVAL OF MONTHLY DISBURSEMENTS**

WHEREAS, the Finance Officer has presented the Town Council with the Revenue Statement Summary and the Encumbrances and Expenditure State Summary of figures for the three months ended September 30, 2024; and

WHEREAS, the Finance Officer did not report any unusual expenditures.

NOW, THEREFORE BE IT RESOLVED THAT the Lewisville Town Council accepts the Revenue Statement Summary and the Encumbrances and Expenditure Statement Summary for the three months ended September 30, 2024 and incorporated herein.

Adopted this the 14th day of November 2024 by the Lewisville Town Council.

ATTEST:

Mike Horn, Mayor

Dora K. Moore, Town Clerk

Town of Lewisville
Financial Budget to Actual Report - General Fund
Three Months Ended September 30, 2024

General Fund

Revenues	Budget	Revenue Year to Date	Revenue Over (Under) Budget	Percentage Collected
Property Tax Collections	\$ 3,770,165.00	\$ 381,578.45	\$ (3,388,586.55)	10.12%
Sales Tax Revenue	1,289,255.00	113,598.57	(1,175,656.43)	8.81%
Other Revenues	1,774,885.00	334,223.53	(1,440,661.47)	18.83%
Transfer from ARPA Special Revenue Fund	-	360,454.46	360,454.46	-
Subtotal	6,834,305.00	\$ 1,189,855.01	\$ (5,644,449.99)	17.41%
Appropriation from Fund Balance	387,586.00			
Total	\$ 7,221,891.00			

Departments	Budget	Expenditures Year to Date	Encumbrances Year to Date	Unencumbered and Unspent Balance	Percentage of Budget Spent or Encumbered
Governing Body	\$ 305,072.00	\$ 57,136.21	\$ 45,284.94	\$ 202,650.85	33.57%
Administration	1,027,257.00	267,833.03	48,049.08	711,374.89	30.75%
Finance	309,693.00	89,038.22	-	220,654.78	28.75%
Debt Service	225,200.00	225,200.00	-	-	100.00%
Planning & Zoning	383,876.00	44,050.02	77,802.00	262,023.98	31.74%
Beautification	130,956.00	23,904.00	100,952.64	6,099.36	95.34%
Community Policing	1,035,720.00	19,982.77	987,184.00	28,553.23	97.24%
Public Works	519,645.00	123,948.54	50,976.59	344,719.87	33.66%
Streets	325,107.00	10,103.68	31,545.37	283,457.95	12.81%
Powell Bill	466,430.00	18,200.00	9,750.00	438,480.00	5.99%
Storm Water	231,157.00	20,203.62	109,448.32	101,505.06	56.09%
Solid Waste	1,605,860.00	233,609.24	-	1,372,250.76	14.55%
Recycling	5,310.00	190.00	-	5,120.00	3.58%
Parks and Recreation	386,781.00	95,310.75	24,360.19	267,110.06	30.94%
Transfers to Willow Run MSD Special Revenue Fund	263,827.00	-	-	263,827.00	0.00%
Transfers to Capital Projects Funds	-	-	-	-	-
Transfers to Capital Reserves	-	-	-	-	-
Total	\$ 7,221,891.00	\$ 1,228,710.08	\$ 1,485,353.13	\$ 4,507,827.79	37.58%

General Fund Balance 7/1/2023	\$ 6,021,921.94
Increase (Decrease) FY 2023-2024 (Preliminary)	1,404,718.13
Year-to-Date Increase (Decrease) FY 2024-2025	(38,855.07)
General Fund Balance 9/30/2024	<u>\$ 7,387,785.00</u>

Town of Lewisville
Financial Budget to Actual Report - Willow Run Municipal Service District
Three Months Ended September 30, 2024

Willow Run Municipal Service District

Revenues	Budget	Revenue Year to Date	Revenue Over (Under) Budget	Percentage Collected
Revenues	\$ 75,016.00	\$ 7,892.10	\$ (67,123.90)	10.52%
Transfers from General Fund	263,827.00	-	(263,827.00)	0.00%
Subtotal	338,843.00	\$ 7,892.10	\$ (330,950.90)	2.33%
Appropriation from Fund Balance	192,872.00			
Total	\$ 531,715.00			

	Budget	Expenditures Year to Date	Encumbrances Year to Date	Unencumbered and Unspent Balance	Percentage of Budget Spent or Encumbered
Expenditures	\$ 531,715.00	\$ 17,500.00	\$ 17,500.00	\$ 496,715.00	6.58%
Total	\$ 531,715.00	\$ 17,500.00	\$ 17,500.00	\$ 496,715.00	6.58%

MSD Fund Balance 7/1/2023	\$ 233,234.96
Increase (Decrease) FY 2023-2024 (Preliminary)	16,546.07
Year-to-Date Increase (Decrease) FY 2024-2025	(9,607.90)
MSD Fund Balance 9/30/2024	<u><u>\$ 240,173.13</u></u>

**Town of Lewisville
September 30, 2024**

Capital Reserve Funds					
	Fund Balance 7/1/2024	Transfers In	Transfers Out	Investment Earnings	Fund Balance 9/30/2024
Sidewalks, Bike Paths, and Greenways Capital Reserve	1,388.16	-	-	18.17	1,406.33
Municipal Buildings/Land Capital Reserve	142,522.09	-	-	1,866.29	144,388.38
Parks & Recreation Capital Reserve	331.15	-	-	4.33	335.48
Total	\$ 144,241.40	\$ -	\$ -	\$ 1,888.79	\$ 146,130.19

American Rescue Plan Act Special Revenue Fund	
American Rescue Plan Act funding received	\$ 4,024,471.50
Transferred to General Fund to reimburse for general government services - revenue replacement - FY 2021-2022	(1,208,168.14)
Transferred to General Fund to reimburse for general government services - revenue replacement - FY 2022-2023	(1,105,602.57)
Transferred to General Fund to reimburse for general government services - revenue replacement - July 1, 2023 through June 30, 2024	(1,335,948.56)
Transferred to General Fund to reimburse for general government services - revenue replacement - July 1, 2024 through September 30, 2024	(360,454.46)
Investment earnings	170,551.08
American Rescue Plan Act Special Revenue Fund - Cash Balance 9/30/2024	\$ 184,848.85

**Town of Lewisville
September 30, 2024**

Capital Projects Funds - Since Inception								
Project	Revenue	Expenditures	Transfers In	Transfers Out	Investment Earnings	Loan Proceeds	Fund Balance 9/30/2024	Budget
Gateway Project Capital Project	2,758,646.45	(3,517,976.42)	1,810,901.90	-	117,916.85	-	1,169,488.78	\$ 4,094,108.90
Community Center Capital Project	100,000.00	(4,804,462.80)	2,947,137.00	-	20,770.84	2,000,000.00	263,445.04	\$ 4,947,137.00
Roundabout at Lewisville-Vienna Road and Robinhood Road Capital Project	592,263.01	(767,425.40)	560,297.00	-	49,947.73	-	435,082.34	\$ 2,801,485.00
Jack Warren Park Improvements	42,929.06	(251,672.47)	672,049.00	-	31,137.98	-	494,443.57	\$ 672,049.00
Lewisville-Vienna Multipurpose Path	-	-	353,291.00	-	21,311.55	-	374,602.55	\$ 1,766,453.00
Shallowford Road CMAQ Sidewalk	-	-	262,933.00	-	12,402.58	-	275,335.58	\$ 1,446,134.00
Great Wagon Road Improvements	-	-	1,924,545.62	-	48,737.48	-	1,973,283.10	\$ 1,924,545.62
Public Works Facility	-	(5,701.33)	899,325.47	-	13,601.21	-	907,225.35	\$ 1,000,000.00
Total	\$ 3,493,838.52	\$ (9,347,238.42)	\$ 9,430,479.99	\$ -	\$ 315,826.22	\$ 2,000,000.00	\$ 5,892,906.31	\$ 18,651,912.52

Lewisville Town Council
Briefing and Action Meeting Minutes
October 3, 2024 – 6:00 PM
Lewisville Town Hall 2nd Floor Conference Room
6510 Shallowford Road

1. Call to Order:

- A. Mayor Pro Tem Hunt opened the meeting at 6:00 PM. In attendance were Mayor Mike Horn (remote), Mayor Pro Tem Melissa Hunt and Council Members Ivan Huffman, Monte Long, Julia Puckett, Ken Sadler and Jane Welch. Also attending were Town Manager Stacy Tolbert, Town Clerk Dora Moore, Finance Director Pam Orrell, Public Works Director Jon Hanna, Planning Director Lynn Cochran, Operations Manager Brian Moore and Town Attorney Elliot Fus.
- B. Adoption of Agenda – Council Member Long moved to approve the agenda with the removal of a shop local event under For the Good of the Order. The motion was seconded by Council Member Huffman and approved unanimously.

2. Items Requiring Council Direction

- A. Staggered terms – Clerk Moore and Attorney Fus shared options for implementing staggered terms. The Town’s options are 1) legislative action; 2) ordinance to change charter; or 3) voter referendum. The process for each option was explained. Council Member Sadler inquired the benefit of staggered terms. Continuity was a reason shared by some members. Council Member Sadler stated that, historically, there have been no adverse effects when there is a large change to the Council and staff does not change. He expressed concern the Town was moving from the intent of the original Town charter. Other reasons supporting staggered terms expressed by Council was the short learning curve of two years, concern of a completely new Council at once, and retaining focus of Council members during the election process.

Council Member Huffman made a motion to move forward with staggered terms. Mayor Pro Tem Hunt seconded the motion. Mayor Horn, Mayor Pro Tem Hunt and Council Members Huffman, Long and Puckett voted in favor. Council Members Sadler and Welch voted in opposition. Motion passed 5-2.

Attorney Fus explained the Council’s next step would be to adopt a resolution of intent to amend the charter and schedule a public hearing. After the public hearing, Council would consider an ordinance to 1) make ordinance effective only upon a vote of the residents (special election); or 2) approve the ordinance to be effective but know it is subject to a referendum petition being filed. Council held a great deal of discussion about the process.

Council Member Sadler made a motion have a referendum. Motion was seconded by Council Member Welch. Attorney Fus noted this does not need to be determined at this time. Mayor Horn and Council Members Sadler and Welch voted in favor. Mayor Pro Tem Hunt and Council Members Huffman, Long and Puckett voted in opposition. Motion failed 3-4. After the vote, Council Member Sadler requested this item be placed on next week’s agenda as New Business.

3. Items Requiring Action at Briefing

- A. Ordinance 2024-032 – Amending Budget Ordinance 2024-001 to increase dependent medical, vision and dental insurance - \$8,650 – An employee has had a qualifying event allowing them to change their insurance coverage; therefore, a budget amendment is needed. Council Member Huffman made a motion to approve Ordinance 2024-032. Motion was seconded by Council

Member Puckett and passed unanimously. (*Ordinance 2024-032 is herein incorporated by reference into the minutes.*)

4. Administrative Reports

A. Town Manager

- i. Great Wagon Road Betterments – North Carolina Department of Transportation (NCDOT) has estimated \$500,000-\$600,000 for the Great Wagon Road betterments of conduit for decorative street lighting, sidewalks larger than the minimum 5 foot and stamped concrete truck aprons with red tint around roundabout to match existing roundabouts in town. Funding for this will come from the Great Wagon Road Capital Project. Council will be requested to approve the agreement at the November 7 briefing in order to meet the NCDOT November 12 deadline.
- ii. Former post office building – There were no surprises with inspections of the former post office building and closing will be October 14.

B. Clerk

- i. The Kruger Brothers, October 5, 4:30-6:30 PM
- ii. Blood Drive, October 9, 1-5:30 PM
- iii. Jumanji movie, October 11
- iv. Bulky item pickup, October 14
- v. Shalloween, October 19, 1-2:30 PM
- vi. Special Recycling event, October 26
- vii. CPR class, November 1, 4-8 PM, MAWCC
- viii. Shallowford Square art call deadline, November 27
- ix. MAWCC mural art call deadline, December 1
- x. Shallowford Square collaboration event update – Clerk Moore shared the collaboration event held by the Public Art and Parks & Recreation committees was held September 9 at Shallowford Square. The committees received great feedback on potential art designs and playground amenities.

Council Member Sadler inquired how community shred events were advertised and inquired if enough are held to cover the community's needs. Shred events are advertised in the Town's newsletter when information is given to staff.

C. Public Works Director

- i. PARTF/Jack Warren Park improvements – The PARTF/Jack Warren Park improvements project continues to progress. It is hoped the pavilion will be delivered late October-early November. The contract is for completion to be done by December 31; however, it is hoped it will be completed mid-November. Manager Tolbert applauded public works for doing a lot of the work which saves the Town money.
- ii. Tree replacement plan – Trees located between the sidewalk and curb in the Ridgecrest area are being replaced due to them damaging infrastructure in the rights-of-way. The trees will be removed and replaced with more adequate trees that contribute to the neighborhood and streetscape. Tree replacement will be phased over three years. Staff is working with the homeowners association to communicate with the neighborhood. Mr. Hanna noted the same issue is occurring in Belgrove. Some trees can be saved but some will have to be replaced. Staff has also worked with this neighborhood's homeowners association and placed door hangers in the neighborhood. Due to the size of the trees, they are too big to be relocated.
- iii. Fall roadway maintenance – A pavement preservation system is being established whereby a portion of Powell Bill funds is used for street maintenance. Albeit unsightly, crack sealing adds

years to streets and it is the Town's job to protect assets with most responsible use of funds. The crack sealing project will be done this fall with resurfacing in spring.

D. Community Center Operations Manager

- i. Quarterly report – Mr. Moore shared the first quarter report for Mary Alice Warren Community Center. *(Report is herein incorporated into the minutes.)*

Break – 7:38 PM – 7:44 PM

5. **Tentative Agenda Items for Regular Meeting on October 10, 2024**

A. Consent Agenda

- i. Resolution 2024-045– Financial statements for two months ended August 31, 2024
- ii. Approval of Agenda Briefing Minutes – September 5, 2024
- iii. Approval of Regular Meeting Minutes – September 12, 2024

B. Introductions, Recognitions, Presentations and/or Proclamations

- i. Introduction
 - a. Lynn Cochran, Planning Director
- ii. Presentation
 - a. Sheriff's Office
- iii. Proclamation
 - a. National Family Literacy Day- November 1, 2024

C. Public Hearings

- i. Unified Development Ordinance amendment – L-168 – Golf Driving Ranges
 - a. Staff presentation
 - b. Public Hearing
 - c. Council discussion
 - d. Council consideration – Ordinance 2024-033– Amend UDO
 1. The proposed UDO amendment establishes minimum standards for driving ranges allowing them in residential zoned areas. Planning Board recommends approval.
- ii. Rezoning – L-110 – 7825 Shallowford Road (PIN 5865-98-6697, 5865-98-5943)
 - a. Staff presentation
 - b. Public Hearing
 - c. Council discussion
 - d. Council consideration – Ordinance 2024-034– Change zoning from Forsyth County RS-40 to Town of Lewisville RS-40 – 7825 Shallowford Road
- iii. Annexation – 7825 Shallowford Road
 - a. Staff presentation
 - b. Public Hearing
 - c. Council discussion
 - d. Council consideration – Ordinance 2024-035 – Extend the Town of Lewisville corporate limits to include 7825 Shallowford Road

D. Appointment

- i. Zoning Board of Adjustment
 - a. Alternate Member (Appoint 1)

E. Old Business

F. New Business

- i. 2025 Meeting schedule
 - a. The proposed 2025 meeting schedule reflects meetings for Town Council, boards and committees. The schedule also reflects the Council retreat, budget meetings and CityVision. Due to CityVision, the May agenda briefing will be held April 24.

- ii. Resolution 2024-046 – Correction to Resolution 2021023 – Declaration of Withdrawal of Road Dedication
 - a. Resolution 2021023 and the *Declaration of Withdrawal Road Dedication* erroneously referenced Lots 17 and 18. The correct lot numbers are Lots 18 and 19.
- iii. Resolution 2024-047 – Remote Participation Policy
 - a. Attorney Fus shared in the recent case of *State of North Carolina v. Anson County*, the North Carolina Court of Appeals held that remote participation by commissioners at a county commissioners meeting did not count toward quorum. Therefore, Attorney Fus is requesting the quorum provisions in the Town’s Remote Participation Policy be revised.
- iv. Resolution 2024-048– Special Projects Review policy
 - a. Clerk Moore shared proposed changes to the Special Projects Review policy are cleanups and includes a more detailed application.
- v. Ordinance 2024-036 – Amending Budget Ordinance 2024-001 – Classification and Compensation Study - \$9,200
 - a. The Town received four responses to the classification and compensation study request for proposals. Manager Tolbert recommends the MAPS Group (The Management and Personnel Services Group), a preferred partner of the North Carolina League of Municipalities. The study will be completed by the end of February 2025 in time for budget preparations. The other firms were unable to complete the study until after the budget process. Scope of work includes:
 - Study orientation sessions with employees
 - Review and study of existing employee positions
 - Conferences with department heads to review and verify info
 - Preparation of job descriptions
 - Determine what positions should be exempt/non-exempt per Fair Labor Standards Act (FLSA).
 - Salary survey of public sector jurisdictions
 - Ensures ranges are competitive and sufficient to attract and retain employees
 - Determination if town’s salaries, benefits & wages are competitive
 - Prepare updated pay plan (salary grades)
 - Give implementation options with costs associated
 - Comprehensive review of the town’s personnel policy
 - Modern & effective HR management
 - Current laws & regulations
- vi. Resolution 2024-049 – Voice and internet contract with Spectrum Enterprise - \$91,440
- vii. Resolution 2024-050– Amendment #2 to Kimley-Horn preliminary engineering contract - Roundabout at Lewisville-Vienna Road and Robinhood Road Project - \$33,066.77
 - a. NCDOT is now requiring wet utilities to be outside of roundabouts. This was not the case when the original contract was approved. The proposed amendment includes:
 - Wet Utility Plans, Specification and Estimate
 - Relocation of approximately 2,150 linear feet of existing water lines.
 - Relocation of hydrants, valves, meters, etc.
 - Additional meetings and coordination associated with the relocation including meetings with the Town, NCDOT, and City of Winston-Salem Utilities.
 - Water Utility Relocation As-Built Drawings required for NCDOT and City of WS Utilities
- viii. Resolution 2024-051 – Utility relocation agreement with Duke Energy - Roundabout at Lewisville-Vienna Road and Robinhood Road Project - \$280,637.89

The next two items were discussed together.

- ix. Ordinance 2024-037 – Amending Great Wagon Road Improvements Capital Project Ordinance - \$6,217,453.72
- x. Resolution 2024-052 – Utility Agreement with the City of Winston-Salem and the NC Department of Transportation - \$6,217,453.72
 - a. Manager Tolbert presented an agreement with the City of Winston-Salem and NCDOT related to utilities for the Great Wagon Road project. The Great Wagon Road Improvements Capital Project Ordinance would need amending also. The agreement states, NCDOT will construct water and sewer lines within the Great Wagon Road, the Town of Lewisville will pay for the installation of the lines, and the City of Winston-Salem will take over ownership and maintenance of the lines after construction. Mrs. Orrell shared the anticipated increase to the water and sewer reserve fund. Once payment is required, it is hopeful the funds will be available in the fund along with other avenues of funding include the upcoming tax revaluation.

Lewisville Water and Sewer Projects	
Updated: 9/4/2024	
Expenses	
Sewer Lift Station Relocation	\$ 5,864,400
GWR Water/Sewer Lines Installation	6,217,454
Estimated Cost	12,081,854
Revenues	
<i>Reserve Held by the W-S/Forsyth County Utility Commission</i>	
Balance 6/30/2024	7,485,617
Estimated contribution FY 24-25	900,000
Estimated contribution FY 25-26	900,000
Estimated Reserves	9,285,617
Estimated Deficit	\$ 2,796,237

6. **For the Good of the Order**

- A. Council Member Welch asked everyone to wear pink at the regular meeting for Breast Cancer Awareness Month.
- B. The Coffee Mill had begun collections for the Western North Carolina communities devastated by Hurricane Helene last week and quickly ran out of room. The Town was able to offer the Galloway Community Center as a collection site. Manager Tolbert commended Town staff for their efforts working the site, answering calls and more.

- 7. **Adjournment** – Council Member Long moved to adjourn the meeting at 8:51 PM. The motion was seconded by Council Member Huffman and approved unanimously.

ATTEST:

Mike Horn, Mayor

Dora K. Moore, Town Clerk

**Lewisville Town Council
Regular Meeting Minutes
October 10, 2024 – 6:00 PM
Lewisville Town Hall Council Chambers
6510 Shallowford Road**

1. Call to Order:

- A. Mayor Horn opened the meeting at 6:00 PM. In attendance were Mayor Mike Horn, Mayor Pro Tem Melissa Hunt, and Council Members Ivan Huffman, Monte Long, Julie Puckett, Ken Sadler and Jane Welch. Also attending were Town Manager Stacy Tolbert, Town Clerk Dora Moore, Finance Director Pam Orrell, Public Works Director Jon Hanna, Planning Director Lynn Cochran and Town Attorney Elliot Fus.
- B. Invocation – Council Member Monte Long
- C. Pledge of Allegiance – Council Member Ken Sadler
- D. Adoption of Agenda – Council Member Huffman moved to approve the agenda as amended. The motion was seconded by Council Member Puckett and approved unanimously.

2. Consent Agenda

- A. Resolution 2024-045– Financial statements for two months ended August 31, 2024
- B. Approval of Agenda Briefing Minutes – September 5, 2024
- C. Approval of Regular Meeting Minutes – September 12, 2024

Mayor Pro Tem Hunt moved to approve the consent agenda items. The motion was seconded by Council Member Huffman and approved unanimously. *(Resolution 2024-045 is herein incorporated by reference into the minutes.)*

3. Introductions, Recognitions, Presentations and/or Proclamations

- A. Introduction of Planning Director
 - i. Manager Tolbert introduced Lynn Cochran as the Town’s Planning Director. Mr. Cochran has worked previously for Rockingham County Planning and Inspections and Piedmont Triad Regional Council.
- B. Presentations
 - i. Sheriff’s Office – Sergeant Stringer shared recent call information. He encouraged everyone to continue praying for Western North Carolina (WNC) noting how the community has come together to help. Mayor Horn, who has been in the Plum Tree community, shared the devastation is quite severe. He expressed pride in staff, Council and volunteers who have helped with relief efforts.

2024													
TYPE OF INCIDENT	JAN	FEB	MAR	APRIL	MAY	JUNE	JULY	AUG	SEPT	OCT	NOV	DEC	TOTAL
Total calls for service	575	657	715	682	605	591	621	698	708				
Security Check	277	347	408	368	300	284	351	357	379				
Traffic Arrest / Violation	34	38	24	30	25	41	36	32	25				285
Alarm	11	1	19	14	16	8	19	12	16				116
Priority Call Response Time	5.9	5	5	4.1	5.4	4.8	5	4.5	5				44.7
2023													
TYPE OF INCIDENT	JAN	FEB	Mar	April	May	June	July	Aug	Sept	Oct	Nov	Dec	Total
Total calls for service	872	676	751	758	754	800	734	769	477				575
Security Check	570	396	136	446	442	518	388	464	207				
Traffic Arrest / Violation	49	47	51	75	41	35	30	72	26				
Alarm	17	23	23	22	15	20	7	7	9				
Priority Call Response Time	5.2	3.6	5.2	5.3	5.9	5	4.1	4.1	6				

- C. Proclamation
 - i. 2024-004 – National Literacy Day – November 1, 2024 (*Proclamation is incorporated into the minutes.*)

4. Public Forum

- A. Susan Frey, 165 Will Austin Court, spoke about concern in amending zoning uses for case-by-case issues. (*Ms. Frey's comments are incorporated into the minutes.*)
- B. Fred Franklin, 1420 Conrad Sawmill Road, spoke against the Council's consideration of staggered terms. (*Mr. Franklin's comments are incorporated into the minutes.*)
- C. Andy Kelly, Historic Nissen House, updated Council on the history display being showcased at local events. He then introduced PJ Lancaster as the new manager for the Historic Nissen House.
- D. PJ Lancaster, 185 Tullyries Lane, shared the Nissen House will now have daytime hours for visitors. She hopes to implement some programs and make the house a history center. She requested the Town help spread the word.
- E. Kyle Stalls, 7823 Wilson Farm Rd, Summerfield, NC, extended thanks for support by the Council shown to the Town of Summerfield regarding deannexation earlier in the year. He strongly encouraged leadership to learn what happened saying local government is not easily navigated in the General Assembly. Mayor Horn thanked Mr. Stalls for his comments stating the General Assembly is developer driven.

5. Public Hearings

- A. Unified Development Ordinance amendment – L-168 – Golf Driving Ranges
 - i. Staff presentation
 - a. Mr. Cochran presented the Planning Board's recommendation for a zoning text amendment. The amendment would allow golf driving ranges in same zoning classifications as golf course, since driving ranges are an accessory to a golf course. Any future requests would require review by the Planning Board. (*Presentation is included with the minutes.*)
 - ii. Public Hearing
 - a. No one spoke.
 - iii. Council discussion
 - a. Mayor Pro Tem Hunt researched five other municipalities and noted this was fairly constant for this use to be allowed in this manner.
 - iv. Council consideration – Ordinance 2024-033– Amend UDO
 - a. Mayor Pro Tem Hunt moved to approve Ordinance 2024-033. The motion was seconded by Council Member Puckett and motion passed unanimously. (*Ordinance 2024-033 is herein incorporated by reference into the minutes.*)
- B. Rezoning – L-110 – 7825 Shallowford Road (PIN 5865-98-6697, 5865-98-5943)
 - i. Staff presentation
 - a. The requested rezoning is for two lots and is part of an annexation request. The lots would be rezoned from Forsyth County RS-40 to Lewisville RS-40, contingent upon annexation of the property.
 - ii. Public Hearing
 - a. Ricky Lyons, petitioner, shared they began the rezoning process with Forsyth County but felt it would be good to be a part of the Town.
 - b. Fred Franklin, 1420 Conrad Sawmill Road, stated it took forty years for the land to be filled with stumps and the property looks better than it did previously.

- iii. Council discussion
 - a. Council Member Welch inquired what other uses would be permitted under this zoning. Mr. Cochran explained the zoning is for residential properties with a minimum lot size of 40,000 square feet. Intense commercial or industrial would not be allowed.
- iv. Council consideration – Ordinance 2024-034– Change zoning from Forsyth County RS-40 to Town of Lewisville RS-40 – 7825 Shallowford Road
 - a. Council Member Huffman moved to approve Ordinance 2024-034. The motion was seconded by Council Member Puckett. Mayor Horn, Mayor Pro Tem Hunt and Council Members Huffman, Long, Puckett and Sadler vote in favor. Council Member Welch voted in opposition. Motion passed 6-1. *(Ordinance 2024-034 is herein incorporated by reference into the minutes.)*

C. Annexation – Satellite – 7825 Shallowford Road

- i. Staff presentation
 - a. The annexation before Council is a non-contiguous annexation consisting of 16.76 acres +/- and is located less than one mile from the Town’s primary corporate limits.
- ii. Public Hearing
 - a. No one spoke.
- iii. Council discussion
 - a. No one spoke.
- iv. Council consideration – Ordinance 2024-035 – Extend the Town of Lewisville corporate limits to include 7825 Shallowford Road
 - a. Mayor Pro Tem Hunt moved to approve Ordinance 2024-035. The motion was seconded by Council Member Huffman and motion passed unanimously. *(Ordinance 2024-035 is herein incorporated by reference into the minutes.)*

6. **Appointment**

- A. Zoning Board of Adjustment
 - i. Alternate Member (Appoint 1)

2024 BOARD APPOINTMENTS
October 10, 2024

<u>Zoning Board of Adjustments</u>	Donald Bolar	Kelly Reavis Jr.
Horn		1
Huffman		1
Hunt	1	
Long		1
Puckett		1
Sadler		1
Welch		1
TOTAL	1	6

Kelly Reavis Jr. was appointed to fill the alternate member position with term expiring March 31, 2027.

7. **New Business**

- A. 2025 Meeting Schedule – Council Member Hunt moved to approve the 2025 Meeting Schedule. The motion was seconded by Council Member Puckett and motion passed unanimously. *(2025 Meeting Schedule is herein incorporated into the minutes.)*

- B. Resolution 2024-046 – Correction to Resolution 2021023 – Declaration of Withdrawal of Road Dedication – Resolution 2021023 and the *Declaration of Withdrawal Road Dedication* erroneously referenced Lots 17 and 18. The correct lot numbers are Lots 18 and 19. Adoption of the resolution would be retroactive to April 18, 2021, the original resolution adoption date. Council Member Long moved to approve Resolution 2024-046. The motion was seconded by Council Member Sadler and motion passed unanimously. *(Resolution 2024-046 is herein incorporated by reference into the minutes.)*
- C. Resolution 2024-047 – Remote Participation Policy – Attorney Fus shared that in the recent case of *State of North Carolina v. Anson County*, the North Carolina Court of Appeals held remote participation by commissioners at a county commissioners meeting did not count toward quorum. Therefore, Attorney Fus is requesting the quorum provisions in the Town’s Remote Participation Policy be revised. Council Member Puckett moved to approve Resolution 2024-047. The motion was seconded by Council Member Huffman and motion passed unanimously. *(Resolution 2024-047 is herein incorporated by reference into the minutes.)*
- D. Resolution 2024-048– Special Projects Review Policy – Council Member Welch moved to approve Resolution 2024-048. The motion was seconded by Council Member Long and motion passed unanimously. *(Resolution 2024-048 is herein incorporated by reference into the minutes.)*
- E. Ordinance 2024-036 – Amending Budget Ordinance 2024-001 – Classification and Compensation Study - \$9,200 – Manager Tolbert requested Council to approve a budget amendment to hire the MAPS Group (The Management and Personnel Services Group), a preferred partner of the North Carolina League of Municipalities, to complete a classification and compensation study in an amount not to exceed \$9,200. The study will be completed by the end of February 2025 in time for budget preparations. Scope of work includes:
- Study orientation sessions with employees
 - Review and study of existing employee positions
 - Conferences with department heads to review and verify info
 - Preparation of job descriptions
 - Determine what positions should be exempt/non-exempt per Fair Labor Standards Act (FLSA).
 - Salary survey of public sector jurisdictions
 - Ensures ranges are competitive and sufficient to attract and retain employees
 - Determination if town’s salaries, benefits & wages are competitive
 - Prepare updated pay plan (salary grades)
 - Give implementation options with costs associated
 - Comprehensive review of the town’s personnel policy
 - Modern & effective HR management
 - Current laws & regulations

Mayor Pro Tem Hunt moved to approve Ordinance 2024-036. The motion was seconded by Council Member Puckett and motion passed unanimously. *(Ordinance 2024-036 is herein incorporated by reference into the minutes.)*

- F. Resolution 2024-049 – Voice and internet contract with Spectrum Enterprise - \$91,440 – Council Member Welch moved to approve Resolution 2024-049. The motion was seconded by Council Member Long and motion passed unanimously. *(Resolution 2024-049 is herein incorporated by reference into the minutes.)*
- G. Resolution 2024-050 – Amendment #2 to Kimley-Horn preliminary engineering contract - Roundabout at Lewisville-Vienna Road and Robinhood Road Project - \$33,066.77 – Due to changes required by North Carolina Department of Transportation, utility plans for the Lewisville-Vienna Road and Robinhood Road roundabout had to be amended to relocate water lines,

hydrants, meters, etc. outside of the roundabout. This amendment also includes additional meetings and coordination associated with the updated plans. Council Member Long moved to approve Resolution 2024-050. The motion was seconded by Council Member Welch and motion passed unanimously. (*Resolution 2024-050 is herein incorporated by reference into the minutes.*)

- H. Resolution 2024-051 – Utility relocation agreement with Duke Energy - Roundabout at Lewisville-Vienna Road and Robinhood Road Project - \$280,637.89 – Council Member Puckett moved to approve Resolution 2024-051. The motion was seconded by Council Member Long and motion passed unanimously. (*Resolution 2024-051 is herein incorporated by reference into the minutes.*)
- I. Ordinance 2024-037 – Amending Great Wagon Road Improvements Capital Project Ordinance - \$6,217,453.72 – The proposed ordinance is to amend the Great Wagon Road Improvements Capital Project Ordinance to increase the project amount by \$6,217,453.72. This budget amendment is required to enter into a 3-party agreement between the Town, NCDOT and the City of Winston-Salem for water and sewer lines to be constructed within the Great Wagon Road during road construction. Council Member Huffman moved to approve Ordinance 2024-037. The motion was seconded by Council Member Puckett. Mayor Horn and Council Members Huffman and Puckett voted in favor. Mayor Pro Tem Hunt and Council Members Long, Sadler and Welch voted in opposition. Motion failed with a vote of 3-4.

Mayor Horn stated that with failure to pass the ordinance, the project stops. Council asked questions about the increased amount, what it included and how additional funding would be acquired. Council also inquired if the road construction and pump station projects could be separated. Manager Tolbert explained the new pump station is being constructed in conjunction with the road construction 1) so lines will be constructed before paving Great Wagon Road and 2) the current pump station cannot handle additional construction as a result of the Great Wagon Road. Mayor Horn stated the Town can pursue grants and supplemental funding. Mayor Pro Tem Hunt suggested reprioritizing current projects to fund the project. Council Member Welch expressed concern about depleting the general fund and suggested placing the new pump station on hold until after road construction is completed.

Council Members Huffman and Long left the room 7:44 PM-7:47 PM.

Council Member Long moved to reconsider the previous motion. The motion was seconded by Mayor Pro Tem Hun and motion passed unanimously.

A break was taken 7:59 PM-8:06 PM to develop wording for the ordinance about using funds from completed projects and evaluating other reserves.

The following additional language to Ordinance 2024-037 was proposed: *To address the potential shortfall, other Town reserves and excess funds in existing capital projects should be considered as funding sources before funding the shortfall from the General Fund.*

Mayor Pro Tem Hunt moved to approve Ordinance 2024-037 with the additional language. The motion was seconded by Council Member Welch and motion passed unanimously. Staff was also requested to explore lift station options. (*Ordinance 2024-037 is herein incorporated by reference into the minutes.*)

- J. Resolution 2024-052 – Utility Agreement with the City of Winston-Salem and the NC Department of Transportation - \$6,217,453.72 – Council Member Puckett moved to approve Resolution 2024-052. The motion was seconded by Council Member Long and motion passed unanimously. *(Resolution 2024-052 is herein incorporated by reference into the minutes.)*
- K. Staggered terms discussion – Council Member Sadler stated Council had a robust discussion at the agenda briefing regarding staggered terms and noted Council voted in favor of staggered terms. He expressed his desire that this decision be made by the residents. Council Members expressed reasons they were for and against staggered terms. Mayor Pro Tem Hunt made a motion directing staff to develop a resolution of intent to be considered by Council at the December 2024 meeting and a public hearing scheduled for the January 2025 meeting. This will provide an opportunity to advertise the public hearing in the *Lewisville Citizen* and to adhere to election schedules for the November 2025 ballot. The motion was seconded by Council Member Huffman and motion passed unanimously.

Agenda was amended to add the next item.

- L. Resolution 2024-053 – Historic Nissen House landmark indicator sign – Council Member Welch moved to approve Resolution 2024-053. The motion was seconded by Council Member Huffman and motion passed unanimously. *(Resolution 2024-053 is herein incorporated by reference into the minutes.)*

8. Administrative Reports

- A. Upcoming events and closings
 - i. Jumanji movie, October 11
 - ii. Bulky item pickup, October 14
 - iii. Shalloween, October 19, 1-2:30 PM
 - iv. Special Recycling event, October 26
 - v. CPR class, November 1, 4-8 PM, MAWCC
 - vi. Shallowford Square art call deadline, November 27
 - vii. MAWCC mural art call deadline, December 1
- B. Approvals at the Briefing and Action Meeting on October 3, 2024
 - i. Ordinance 2024-032 – Amending Budget Ordinance 2024-001 to increase dependent medical, vision and dental insurance - \$8,650
 - ii. Council voted to move forward with staggered terms

9. For the Good of the Order

- A. Public comments
 - i. Fred Franklin, 1420 Conrad Sawmill Road, expressed disappointment in Council for taking up action on staggered terms. He further commented the sewer lift station is at capacity and a new station is needed to replace the old one and open development along Great Wagon Road.
- B. Council comments
 - i. Mayor Pro Tem Hunt thanked Town and staff for what is contributed to the State as a whole, hosting training, Mayor serving on NCLM Board, etc.
 - ii. Council Member Puckett thanked everyone for staying and speaking up noting this is why they serve.
 - iii. Mayor Horn extended prayers and thoughts to those impacted by recent storms in WNC and Florida. Many communities in WNC no longer exist and many people have a daunting task to rebuild.
 - iv. Council Members Puckett and Welch noted October is Breast Cancer Awareness Month.

10. **Adjournment** – Council Member Long moved to adjourn the meeting at 8:51 PM. The motion was seconded by Council Member Huffman and motion passed unanimously.

ATTEST:

Mike Horn, Mayor

Dora K. Moore, Town Clerk

DRAFT



TOWN OF LEWISVILLE 2025 MEETING SCHEDULE

BOARDS & COMMITTEES	TIME	PLACE	DAY	JAN	FEB	MAR	APR	MAY	JUN	JUL	AUG	SEP	OCT	NOV	DEC
Beautification Committee	6:00 PM	TH 201	MON		17	17		19				15	20		
Environmental Committee	6:00 PM	TH 201	TUE	14	11	11	8	13	10	8	12	9	14		9
Parks & Recreation Committee	6:00 PM	TH 201	MON	13	10	10		12	9	14	11	8	13	10	8
Planning Board	6:00 PM	TH 201	WED	8	12	12	9	14	11	9	13	10	8	12	10
Public Art Committee	6:00 PM	TH 201	MON	6		3	7	5	2	7	4		6	3	1
Willow Run MSD Board	6:00 PM	TH 201	TUE	21		18		20			19		21		
Zoning Board of Adjustment	6:00 PM	TH 110	TUE	28	25	25	22	27	24	22	26	23	28	25	23

TOWN COUNCIL	TIME	PLACE	DAY	JAN	FEB	MAR	APR	MAY	JUN	JUL	AUG	SEP	OCT	NOV	DEC
Agenda Briefing	6:00 PM	TH 201	THUR	2	6	6	3	24-Apr	5	3	7	4	2	6	4
Regular Meeting	6:00PM	TH 110	THUR	9	13	13	10	8	12	10	14	11	9	13	11
Council Retreat		MAWCC	January 31 - 5:30 PM; February 1 - 8:30 AM												
Budget Work Sessions	6:00 PM	TH 110	April 14, April 21, April 24, May 15 (Note: Budget work sessions only held if needed.)												
NCLM CityVision			April 29-May 1												

Planning Board If there is a public hearing, the Planning Board meets in TH 110 (Council Chambers).

Zoning Board of Adjustment - Only meets as needed.

MAWCC - Mary Alice Warren Community Center; TH - Town Hall
 Room 201 is the second floor conference room. Room 110 is the Council Chambers.

Individuals requiring special accommodations may contact the Town Clerk at least 72 hours prior to meetings to request special assistance (336-945-1022).



**RESOLUTION 2024-055 OF THE TOWN OF LEWISVILLE
TECHNICAL REVIEW FOR COMPLIANCE – SITE PLAN REVIEW
ISSUED BY THE LEWISVILLE TOWN COUNCIL FOR L-PBR 2024002**

WHEREAS, the Lewisville Planning Board reviewed the attached site plan regarding the construction of a subdivision on Shady Brook Lane at their meeting on September 11, 2024; and,

WHEREAS, this site plan includes fifty-six (56) lots.

NOW THEREFORE BE IT RESOLVED BY THE LEWISVILLE TOWN COUNCIL that:

Section 1. The properties included in the site plan attached herein consists of 25.37 acres; and,

Section 2. The developer has or will need to follow major subdivision requirements in Chapter D Section 4 of the Unified Development Ordinances, including but not limited to the comments below:

- a. Street tree requirement of one (1) tree per forty-five (45) linear feet plus one (1) additional tree per lot.
- b. Sidewalks on both sides of the street.
- c. Type III buffering along Shady Brook Lane.

Section 3. The developer has or will need to remedy the comments made by the Technical Review Committee (TRC) and obtain any required permits.

Adopted this the 14th day of November 2024 by the Lewisville Town Council.

Mike Horn, Mayor

ATTEST:

Dora K. Moore, Town Clerk

STAFF REPORT

Shady Brook Acres Subdivision

DOCKET: L-PBR 2024002

STAFF: Adam Barr, Planner

Petitioner: Justin Mendenhall, Arden Group, LLC

Ownership: Graybrook Investments, LLC; &
William Reynolds

REQUEST: Preliminary Major Subdivision

A major subdivision in the RS-9 zoning district. The meeting requires review for compliance by the Planning Board and final approval by the Town Council.

PIN#(s): 5885-86-9410 &
5885-87-7174 (portion of)

Acreage: 25.37 Acres

LOCATION:

Street: Shady Brook Ln

Jurisdiction: Town of Lewisville

PROPERTY SITE/IMMEDIATE AREA:

Existing Structures on Site: The site currently has a single-family home on the southern property.

Adjacent uses:

- * North – Existing single-family residences, zoned RS-9.
- * East – Existing single-family residences, zoned RS-9.
- * South - Existing single-family residences, zoned RS-9.
- * West - Existing single-family residences, zoned RS-9.

GENERAL AREA:

Character/Maintenance: The area is made up of single-family dwellings on small to medium sized lots. The area surrounding this 56-lot development is made up of established neighborhoods.

PHYSICAL FEATURES:

Topography: The site gently slopes from north to south, with a steeper slope running west to east at the half of the properties.

Vegetation/habitat: The majority of site is predominately wooded.

Watershed: The property is not located within a watershed.

WATER AND SEWER FACILITIES:

Public water and sewer are available to the site.

TRANSPORTATION:

Direct Access to Site: Shady Brook Ln

Street Classification(s): Local arterial

CONFORMITY TO PLANS:

Lewisville Unified Development Ordinance (UDO) - A site plan has been submitted for review of compliance with the Unified Development Ordinance. The site plan has been reviewed by staff and persons from the Technical Review Committee including the following agencies: Planning, Inspections, Addressing, Fire, Utilities, Stormwater, NCDOT, and Erosion Control. The proposal is for a 56 lot, preliminary major subdivision for single-family homes. Overall, the proposal meets the requirements of the UDO.

Lewisville Comprehensive Plan - The Plan describes this area as the Neighborhood Residential future land use. Neighborhood Residential accounts for many of the suburban-style, lower-density residential areas that have been built during the past 20 years. While most of the existing neighborhoods have a uniform housing type, future Neighborhood Residential areas should promote a mixture of housing sizes and prices as well as efficient neighborhood design, where appropriate. Neighborhood Residential areas of the future could include single-family homes and townhomes in a clustered design.

Legacy Development Guide - *Legacy* recognizes this area as being in GMA-3 Suburban Neighborhoods. *Legacy* states GMA-3 areas should be used for increasing overall residential density. Subdivisions in GMA-3 cater to specific housing styles and price ranges.

ANALYSIS:

The applicant is requesting a preliminary major subdivision approval in RS-9 zoning. The preliminary major subdivision plat does adhere to the RS-9 and major subdivision standards. The plan shows required sidewalks on both sides of the street, street tree requirements of 1 tree per 45 linear feet plus 1 additional tree per lot, and type III buffering along Shady Brook Ln.

Town staff is of the opinion that the request is in general conformance with the Town's *Comprehensive Plan and Legacy* for the area. The developer has or will need to follow the major subdivision requirements in Chapter D Section 4, remedy the comments made by the TRC and obtain any required permits.

RECOMMENDATION:

Town staff is of the opinion that the request meets the standards of the Unified Development Ordinance. The site has available infrastructure to support the density of development that is being proposed. Statements found in both the *Lewisville Comprehensive Plan* and *Forsyth County Legacy Plan* encourages the diversification of housing stock in ways that are sensitive to established residential areas.

Lewisville Technical Review Committee (TRC)

PRELIMINARY SITE PLAN REVIEW RECORD

- 1) SITE PLAN TITLE AND NUMBER: Shady Brook Acres, L-PBR 2024002
- 2) TYPE OF DEVELOPMENT: Conventional Preliminary Subdivision Plan Review
- 3) ACREAGE: 25.37 Acres
- 4) ZONING: Existing: RS-9
Proposed Review: Preliminary Major Subdivision
- 5) # UNITS/LOTS: 56
- 6) DENSITY, IF RESIDENTIAL: 2.21 Units Per Acre
- 7) LOCATION OF DEVELOPMENT: Subdivision is located on Shady Brook Lane.
- 8) SITE PLAN PREPARER: Allied Design, INC
4720 Kester Mill Road
Winston-Salem, NC 27103
(336) 765-2377
- 9) OWNER AND/OR AGENT: Arden Group, LLC
PO Box 5323
Winston-Salem, NC 27113
(336) 442-1225
- 10) PRELIMINARY CONDITIONS: Conditions on the following pages are additional requirements for development. All other city or county code regulations still apply.

Lewisville Planning: Adam Barr abarr@lewisvillenc.net

- Please show measurements of the radius of the Cul-de-sac and associated right of way of the western cul-de-sac. *
- Provide a length and width for all street pavement. *
- The T-shaped turnaround will need to meet the following requirements:
*Section D.5-B(1)(i): T-shaped turnarounds shall have an improved street area of twenty-six (26) feet by sixty (60) feet with twenty-five (25) foot radii perpendicular and symmetrically located at the end of the street. The public right-of-way for these turnarounds shall be a minimum of forty-five (45) feet by seventy-five (75) feet centered on the improved street area. **
- A type 3 bufferyard will be required along Shallowford Rd. *
- Sidewalks will be required on both sides throughout the project. *
- Street trees will be needed throughout the project. *
- The RS9 Typical Building Layout shows the intention to meet setback requirements, however there are several building envelopes shown on the site plan that do not seem to meet setback requirements. *
- Label Carrington Oaks Drive. *
- Label all structures to be removed. *
- Provide negative access easements on the lots along Shady Brooke. *
- Provide for vehicular circulation to mitigate traffic for the proposed mail kiosk. *

*Items with an * have already been addressed on the most current plan.

Addressing: Matthew Hamby hambyme@forsyth.cc

-

Erosion Control: Matthew Osborne matthewo@cityofws.org

- If the proposed project creates more than 10,000 sq. ft. of land disturbance (20,000 sq. ft. of land disturbance for Single-Family Dwelling construction), a Grading/Erosion Control Permit will be required prior to the start of work. In order to obtain this permit you must submit a professionally designed Erosion Control Plan along with an original signed/notarized Financial Responsibility/Ownership (FRO) form for review and approval. Please submit the plan through the electronic plan review portal as application type 04.02 Grading/Erosion Control Permit at the following link: <https://winston-salem.idtplans.com/secure/>

Fire: Mark Johnson johnsome@forsyth.cc

- Need to provide the fire flow. Homes with 0-3600 sqft need to provide 1500 gpm for 2 hrs.
- Provide approved turnarounds for fire apparatus:

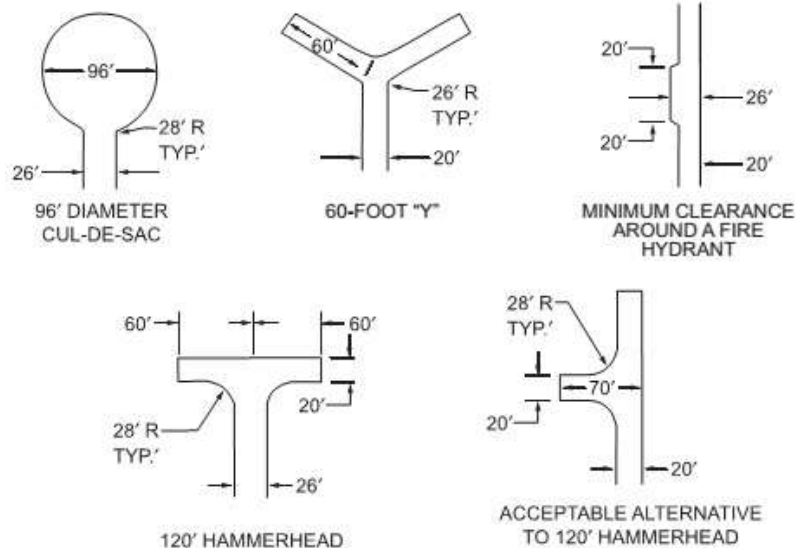

Local Fire: Darin Needham DarinN@lewisvillefire.com

- There do not appear to be any significant fire protection concerns. It is interesting that with the extension of Carrington Oaks Drive that a second fire hydrant is proposed, within 60' of an existing hydrant. I suppose this is required by City/County Utilities.
- Will the fire hydrants in this subdivision be public or private? There has been a significant increase in the number of "private" hydrant systems with City/County Utilities. This will become an issue regarding maintenance and testing. Who will test and provide documentation for the fire department's ISO grading process? If the fire department tests and damages a private system, we would be liable for repair costs. If the system is not tested by a third party and records provided, it can affect ISO grades.

Inspections: Nick Smith nicks@cityofws.org

- No comments at this time.

NCDOT: Ashley Long amlong1@ncdot.gov

- No comments at this time.

Historic Resources: Heather Bratland heatherb@cityofws.org

- No comments at this time.

Stormwater: Kevin Kubiak Kevin.Kubiak@stantec.com

- This development qualifies as high density. They will be required to follow stormwater design standards for high density and submit calculations in accordance with the ordinance. These calculations will include pre- vs post- developed conditions, as well as SCM Calculations. The single inlet capturing rear yard drainage is also of concern and they should provide inlet capacity calculations for the inlet shown between lots 50 and 51. They will also need to provide information to confirm that the storm system discharge toward the existing ditch will not cause any negative impacts to the downstream channels/streams and will not cause any erosion.

Utilities: Chris Jones charlesj@cityofws.org

- Any existing connections not intended for reuse must be terminated at the main. Submit water/sewer extension plans, in IDT, to Utilities Plan Review. Water meters purchased

through COWS. Utilities System Development Fees are due at the time of new meter purchase.

REVIEW INFORMATION	
TYPE OF REVIEW:	X PRELIMINARY SUBDIVISION
JURISDICTION:	X TOWN OF LEWISVILLE
PURPOSE STATEMENT:	THE PURPOSE OF THIS SUBMITTAL IS FOR APPROVAL OF PRELIMINARY SUBDIVISION PLAN.
INFRASTRUCTURE	
WATER:	PUBLIC PRIVATE
SEWER:	X
STREETS:	X
LINEAR FEET OF PUBLIC STREETS:	2,245 FT
OFF-STREET PARKING	
PROPOSED USE(S):	RESIDENTIAL BUILDING, SINGLE FAMILY
REQUIRED PARKING:	2 SPACES PER RESIDENCE
	2 SPACES x 56 LOTS = 112
REQUIRED PARKING:	112 SPACES
PARKING PROVIDED:	112 SPACES
SITE SIZE AND COVERAGES	
TOTAL ACREAGE:	25.37 ACRE(S)
SITE COVERAGES:	
BUILDING TO LAND:	12.67 %
PAVEMENT TO LAND (STREET, SIDEWALKS AND DRIVEWAYS):	12.11 %
OPEN SPACE:	75.22 %
TOTAL:	100 %
MAXIMUM BUILDING HEIGHT:	40'

ZONING	
EXISTING ZONING:	RSS
PROPOSED ZONING:	RSS (NO CHANGE)
PROPOSED USES:	RESIDENTIAL BUILDING, SINGLE FAMILY
DENSITY CALCULATIONS	
# OF UNITS OR LOTS:	56
DENSITY:	2.21 UNITS/LOTS PER ACRE
BUFFERYARDS	
ADJOINING ZONING:	RSS
TYPE REQUIRED:	TYPE 3 ALONG SHADY BROOK LANE
WIDTH PROVIDED:	15'
STREET INDEX CALCULATION	
NUMBER OF SEGMENTS:	5
NUMBER OF NODES:	4
SEGMENTS / NODES:	1.25
WATERSHED INFORMATION	
SUBJECT PROPERTY IS NOT LOCATED WITHIN A WATERSHED DISTRICT.	

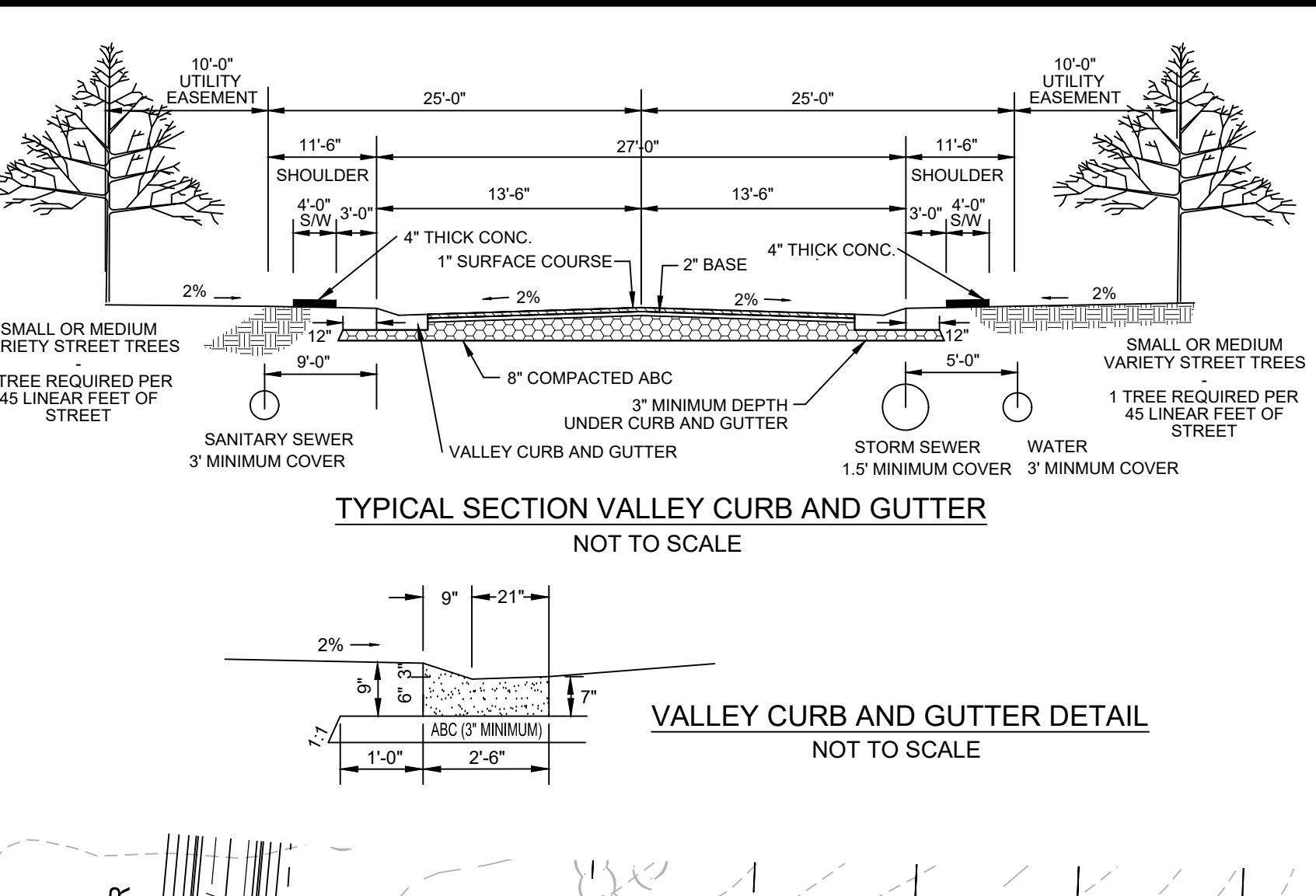
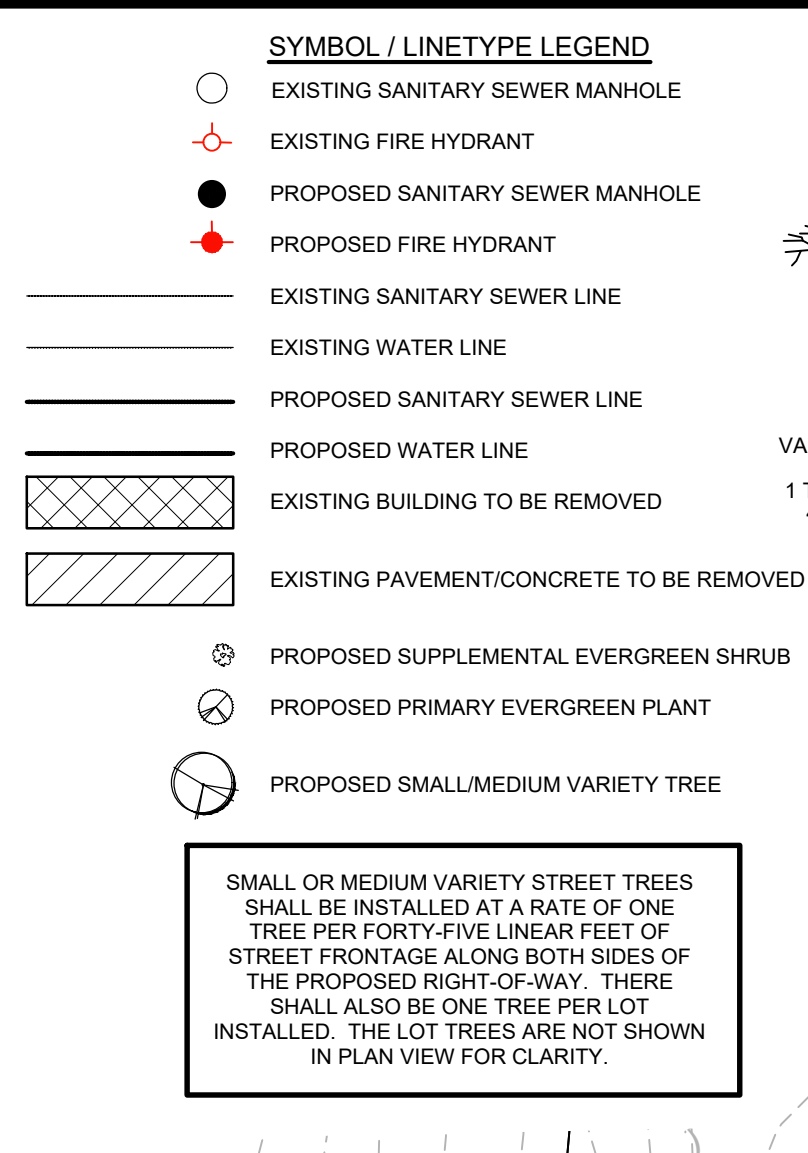
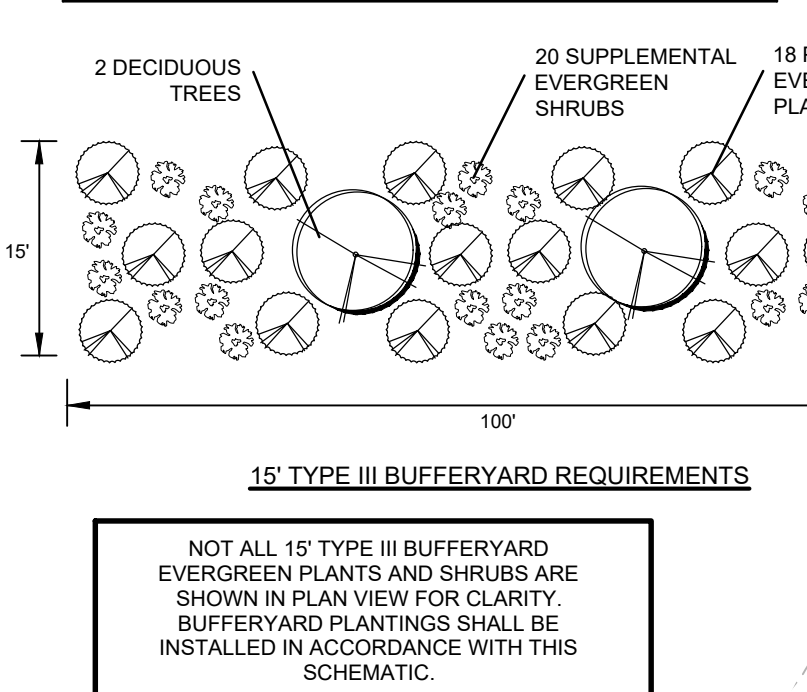
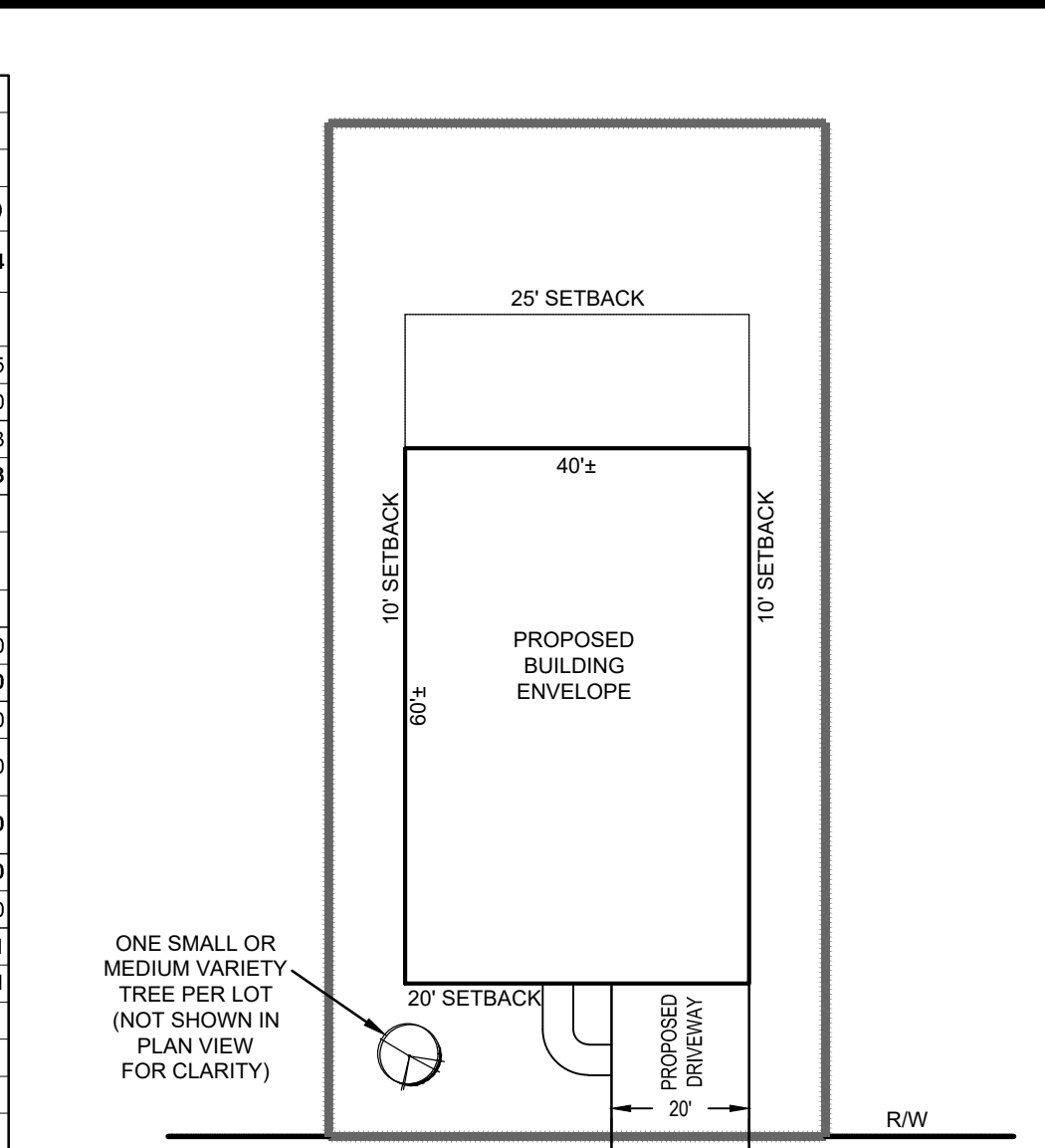

PROPERTY INFORMATION:
 PARCEL ID NUMBER: PORTION OF 5885-87-7174 000
 ACREAGE: 25.37
 5885-86-9410 000
PROPERTY OWNER:
 PORTION OF 5885-87-7174 000
 WILLIAM NOAH REYNOLDS
 PO BOX 2857
 WINSTON-SALEM, NC 27114
 5885-86-9410 000
 GRAYBROOK INVESTMENTS, LLC
 2908 TONG RIDGE LANE
 EAST BEND, NC 27018
DEVELOPER:
 ARDEN GROUP, LLC
 PO BOX 3353
 WINSTON-SALEM, NC 27113
 CONTACT: JUSTIN MENDENHALL
 PHONE: 336-442-1225
 EMAIL: justin@ardenhomes.com
ENGINEER:
 ALLED DESIGN, INC.
 4720 KESTER MILL ROAD
 WINSTON-SALEM, NC 27103
 PHONE: (336) 765-2377
 EMAIL: scausey@allegd-engineur.com

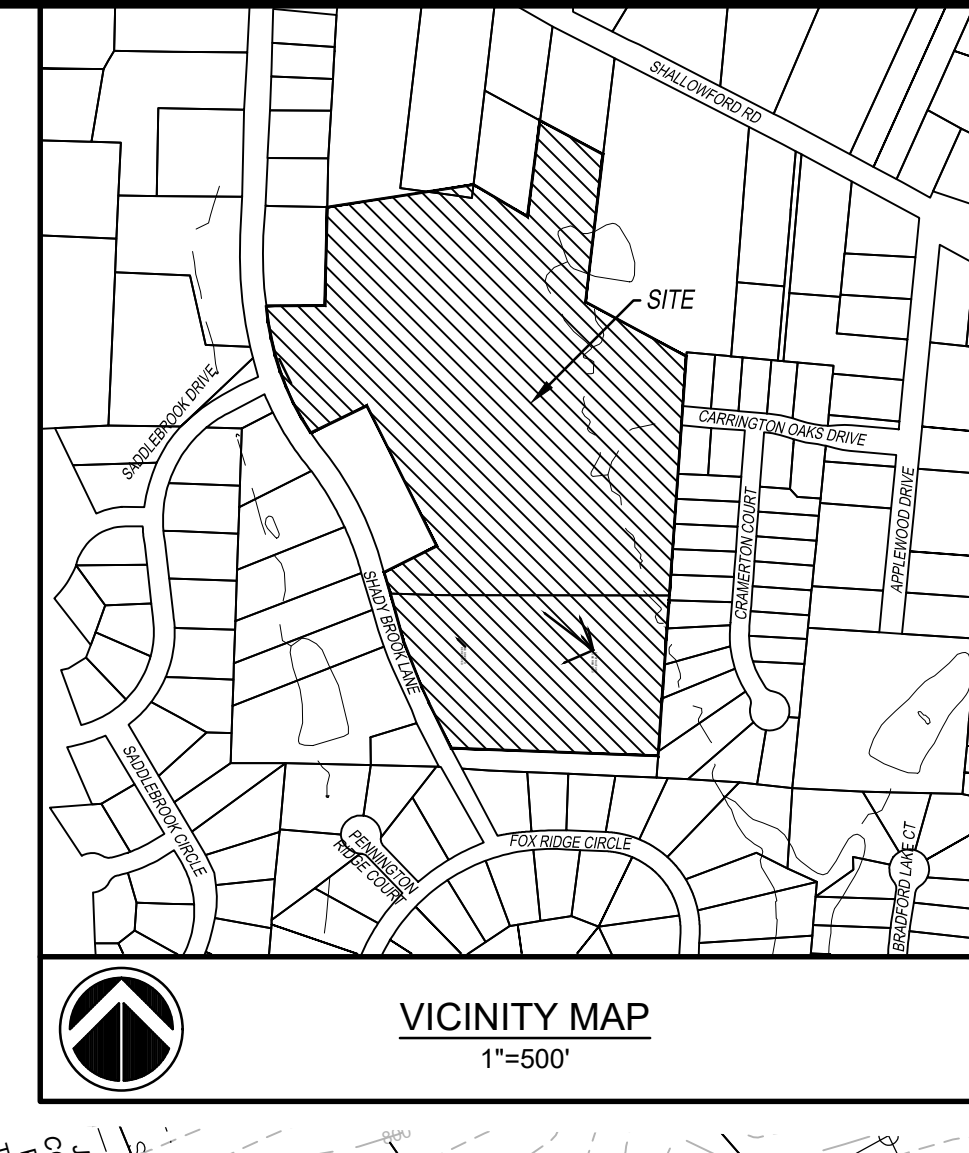

- GENERAL NOTES**
- EXISTING SITE BOUNDARY, LOCATION AND TOPOGRAPHIC INFORMATION WAS TAKEN FROM AVAILABLE CITY/COUNTY MAPS. EXISTING CONTOURS ARE SHOWN AT 2 INTERVALS. PROPOSED CONTOURS ARE SHOWN AT 2 INTERVALS.
 - ALL DEVELOPMENT SHALL CONFORM WITH THE TOWN OF LEWISVILLE "UNIFIED DEVELOPMENT ORDINANCE".
 - ALL DIMENSIONS ARE TO EDGE OF PAVEMENT, FACE OF CURB AND FACE OF BUILDING, UNLESS OTHERWISE NOTED. VERIFY ALL BUILDING DIMENSIONS WITH ARCHITECT PRIOR TO START OF CONSTRUCTION.
 - PUBLIC WATER AND SEWER SHALL BE INSTALLED IN ACCORDANCE WITH THE REQUIREMENTS OF THE CITY/COUNTY UTILITIES COMMISSION AND IN ACCORDANCE WITH THE STANDARDS AND SPECIFICATIONS OF THE CITY OF WINSTON-SALEM, MOST CURRENT EDITION.
 - JURISDICTION: TOWN OF LEWISVILLE

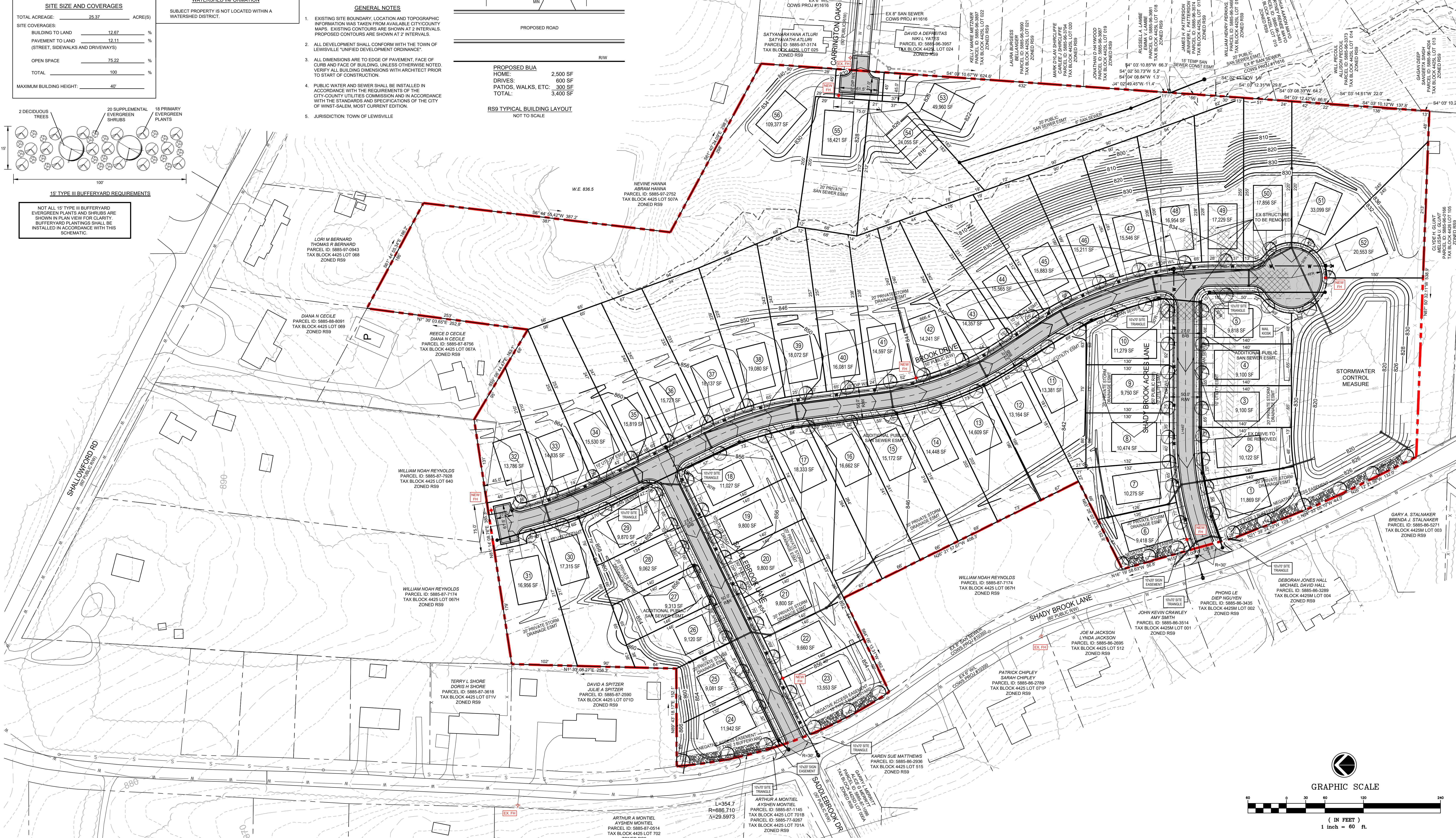
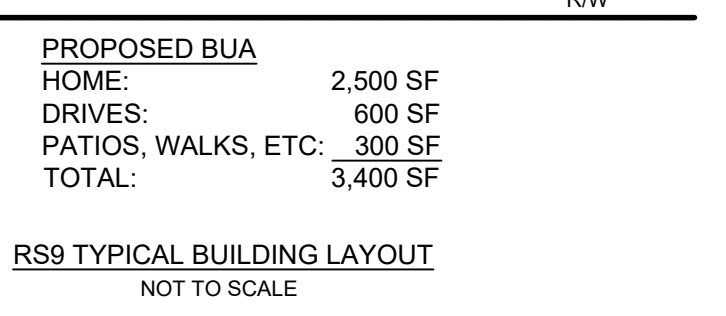

Alled Design, Inc.
 CIVIL ENGINEERING AND SURVEYING
 4720 KESTER MILL ROAD
 WINSTON-SALEM, NORTH CAROLINA 27103
 Phone: (336) 765-2377
 Fax: (336) 765-8886
 http://www.alled-engineur.com

PROFESSIONAL SEAL
 JUSTIN MENDENHALL
 CIVIL ENGINEER
 STATE OF NORTH CAROLINA
 EXPIRES 12/31/2024

PRELIMINARY PLANS
 FOR PLANNING BOARD REVIEW ONLY

SHADY BROOK ACRES
 ARDEN GROUP, LLC
 SHADY BROOK LANE
 LEWISVILLE, NORTH CAROLINA

PROJECT NO.:	24-028
DRAWN BY:	JMN
CHECKED BY:	SNC
DATE:	04/17/2024

NO.	DATE	REVISIONS
A	04/17/2024	ISSUED FOR PRELIMINARY REVIEW
B	05/02/2024	ISSUED FOR PLANNING BOARD APPROVAL
C	06/07/2024	ISSUED FOR PLANNING BOARD APPROVAL

PRELIMINARY SUBDIVISION PLAN
 SHEET
C1

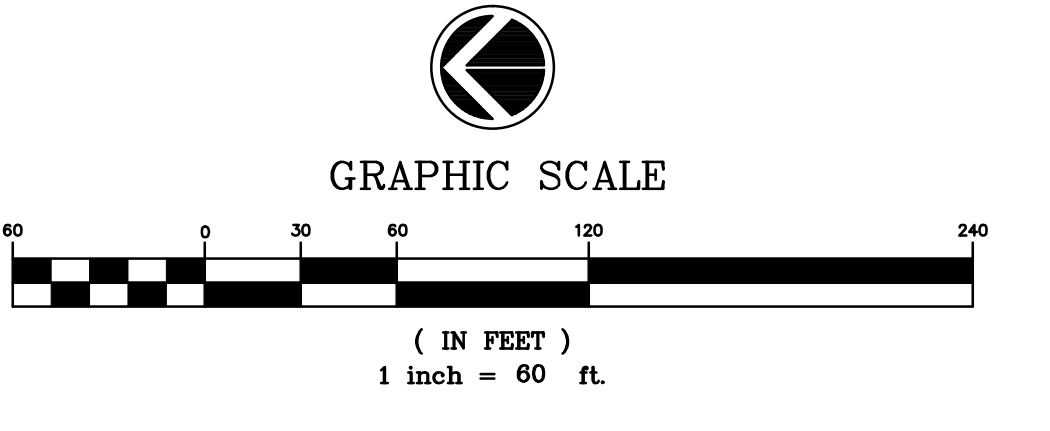



**RESOLUTION 2024-056 OF THE LEWISVILLE TOWN COUNCIL
TECHNOLOGY USE POLICY**

WHEREAS, NCGS 143-805, effective October 1, 2024, requires all public agencies to adopt a policy governing the use of its network and devices owned, leased, maintained, or otherwise controlled by the Town of Lewisville; and,

WHEREAS, the Town of Lewisville has an administrative technology policy effective October 19, 2012.

NOW THEREFORE BE IT RESOLVED that the Lewisville Town Council amends and adopts the Technology Use Policy to be applicable to all Town employees, elected officials and appointees utilizing any device or network owned, leased, maintained or otherwise controlled by the Town of Lewisville.

BE IT FURTHER RESOLVED:

1. Each year, and no later than August 1, the Town shall report information required in NCGS 143-805 to the State Chief Information Officer.
2. This policy shall not apply to investigation, law enforcement training, or actions related to law enforcement purpose; identifying potential security or cyber security threats; establishing, testing and maintaining firewalls, protocols and otherwise implementation of this policy; or other exceptions as specifically set forth in NCGS 143-805(d).
3. The terms used in the policy shall be defined as set forth in NCGS 143-805(g).
4. Any employee, elected official, or appointed of the Town who has saved pornography to a device owned, leased, maintained or otherwise controlled by the Town shall remove, delete or uninstall the pornography no later than January 1, 2025.
5. Any Town employee who violates any provision of this policy shall be subject to disciplinary action under the Town's Personnel Policy.
6. Any Town appointee who violates any provision of this policy shall be subject to removal by Town Council.
7. Any elected official who violates any provision of this policy shall be subject to censure proceedings.

Resolved, approved and effective upon adoption, this the 14th day of November 2024 by the Lewisville Town Council.

Mike Horn, Mayor

ATTEST:

Dora K. Moore, Town Clerk



Town of Lewisville Technology Use Policy

Table of Contents

I.	Scope and Ownership	2
III.	Policy violation	2
IV.	Personal Use.....	2
V.	Monitoring and Privacy.....	3
A.	Monitoring, Auditing, and Inspection Activities	3
B.	Privacy expectations.....	3
VI.	Security.....	3
A.	Administrative Privileges.....	4
B.	Passwords and User System Access.....	4
C.	Physical Security.....	4
D.	Application Security Standards	5
E.	Third Party Access to Town of Lewisville Systems	5
F.	Reporting Violations.....	5
VII.	Prohibited Use.....	5
VIII.	Remote Access	6
IX.	Hardware/Software Standards, Procurement, and Installation	6
X.	Electronic Messaging	6
A.	Town Representation	6
B.	Personal Messaging Accounts.....	6
C.	Internal Broadcast Messages	7
D.	Public Record and Retention.....	7
XI.	Town Internet Content.....	7
XII.	Phone	7

XIII. Storage Media Recycling and Disposal..... 8
XIV. Surplus..... 8

DRAFT

I. Scope and Ownership

This policy applies to all Town of Lewisville technology systems (hardware, software, voice/data networks, user accounts, and associated processes/services) owned, leased, or otherwise operated by Town of Lewisville. The scope of the policy also includes all individuals who have access to Town of Lewisville systems (employed by the Town or not).

Systems containing Town of Lewisville data which are hosted by third parties outside of the Town of Lewisville network, and the personnel with access to those systems are also subject to this policy.

All technology resources defined in this section, along with all information transmitted by, received from, and stored upon said systems are considered to be possessed by, and/or the property of Town of Lewisville.

Because technology systems are constantly evolving, the Town requires its employees to use a common sense approach to the rules set forth below, complying not only with the letter, but also the intent and spirit, of this policy. Failure to adhere to this policy places the Town and the individual at risk for legal and financial liabilities, potential embarrassment and other possible consequences. The Town Manager or his/her designee shall periodically review this policy and recommend changes to the Town Council for adoption as technology options or possibilities evolve.

II. Public Record

As a public entity, the Town of Lewisville and all communications, records, or images created by the Town are subject to the North Carolina public records law unless specifically exempted by statute. This includes telephone records, web pages visited, business related e-mail and any other electronic record or electronic message created, received or stored by the Town.

III. Policy violation

When a policy violation occurs, aside from disciplinary actions specified under Town policy, system access may be revoked in whole or in part if deemed to be in the interest of Town of Lewisville system security and/or availability.

IV. Personal Use

Town of Lewisville systems are intended for business use. Any personal use must adhere to the following:

- must not violate applicable laws or regulations
- must not violate contractual agreements or intellectual property rights

- must not violate Town of Lewisville personnel policies
- must not incur security risk to the Town
- must not incur any additional cost to the Town
- must not interfere with work duties
- must not be used for personal gain
- must not be used for solicitation

V. Monitoring and Privacy

Town of Lewisville has the right to monitor, audit, and/or inspect any and all aspects of the Town's electronic technology resources without advance notice to any users. Failure to monitor in any specific situation does not constitute a waiver of the Town's right to monitor.

Personnel within scope of this policy are advised that they have no privacy rights and that there is no reasonable expectation of privacy when using Town systems.

A. Monitoring, Auditing, and Inspection Activities

At the request of a department director for one of their respective employees, or upon authorization by the Town Manager or his/her designee, the Town Manager or his/her designee has the authority to monitor and/or inspect any Town of Lewisville systems without notice to users.

For security and network and computer systems maintenance purposes, the Town Manager or his/her designee may monitor equipment, systems, data and network traffic at any time.

B. Privacy expectations

The Town of Lewisville does not guarantee the confidentiality of user information stored on any network, computer, or communications device belonging to the Town of Lewisville.

The Town of Lewisville's users should be aware that the data they create on Town technology or communications systems remains the property of the Town of Lewisville and is not private (unless the data is protected by privacy or confidentiality laws).

Information that is stored on or transmitted to or from Town systems may be subject to disclosure pursuant to the North Carolina Public Records Law.

VI. Security

Town of Lewisville system security must be maintained at all times. Users must take all reasonable precautions, including but not limited to: safeguarding passwords, maintaining reasonable physical security around the Town of Lewisville equipment, and locking or logging off unattended workstations.

A user who is actively logged on to a Town of Lewisville system is responsible for any activity that occurs whether or not they are present.

A. Administrative Privileges

For security reasons, administrator-level network, server, and PC access, is limited to the Town Manager or his/her designee support staff and/or their designees. Administrator privileges will not be extended to users in order for software to operate – software vendors are responsible for providing software that will operate without administrator privileges.

Adjustments to security on certain directories of the computer systems may be approved in certain instances at the written request of a department and acknowledgement of the Town Manager and Information Technology support staff. The goal is to accomplish the needs of the user while logging the install for reference while not comprising the integrity of the network.

B. Passwords and User System Access

The Town of Lewisville Town Manager or his/her designee is responsible for creation, assignment, and deletion of all user accounts for the Town of Lewisville systems. The level of access to the network, servers, applications, and personal computers will be administered by the Information Technology Department based upon the job tasks for the individual user as agreed upon with the department head.

Users are responsible for protecting their passwords and access to assigned accounts (network, systems, applications, etc.) at all times.

C. Physical Security

Shared Town of Lewisville systems (network, servers, systems, etc.) will be physically secured by the Town Manager or his/her designee.

- Access to the server room, disaster recovery site, phone switches, and other key infrastructure is limited with access granted to authorized personnel only.
- Media, such as daily and monthly backups, will be stored in a secure area with access granted to authorized personnel only.

Users are responsible for the physical security of assigned technology resources.

- To the degree possible, technology resources should be protected from theft and/or vandalism, fire and other natural environmental hazards.
- Laptops, tablets, etc. in vehicles must be stored in a secure location or otherwise out of sight. They may never be left in a vehicle overnight.
- Employees should exercise precautions to make sure that their computer hardware is not exposed to dangers related to their specific use, i.e. accidental beverage spills, improper ventilation of air intakes, etc.
- Those who are assigned technology resources will be held responsible for those technology resources and will be required to reimburse the Town of Lewisville for replacement or repair of the device or accessories if lost or damaged due to neglect, misuse, or any other instance where found to be at fault as determined by Town management.

D. Application Security Standards

All software applications which manage sensitive or confidential data, whether acquired from a third party or developed internally must adhere to the following security requirements:

- Must support authentication of individual users.
- Must not store or transmit user credentials in a clear text or easily reversible form.
- Must support application scope restriction based on user levels.
- Must support user tracking for critical transaction activity.

E. Third Party Access to Town of Lewisville Systems

No third party may be allowed access to Town of Lewisville systems without approval from the Town Manager or his/her designee.

F. Reporting Violations

The Town should have procedures in place to monitor compliance with the technology use policies within this document, and to report violations (both by "insiders" such as employees and contractors and "outsiders" such as unauthorized visitors, trespassers and hackers).

It is the responsibility of each technology user to remain diligent in the identification and reporting of technology policy violations. Staff should be aware of their environment and report any suspicious, abnormal or unnatural behavior or events to his or her supervisor and the Information Technology Department.

VII. Prohibited Use

The following is a list of examples of prohibited uses. This is not intended to be a comprehensive and complete list. Other uses not listed here may be deemed as prohibited.

- Any use that violates federal, state, or local law or regulation is expressly prohibited.
- Knowingly or recklessly interfering with the normal operation of computers, peripherals, or networks is prohibited.
- Connecting unauthorized equipment to the network for any purpose is prohibited unless approved by the Information Technology Department.
- Running or installing unauthorized software on the Town of Lewisville computers is prohibited.
- Copying of any software from the Town of Lewisville computers, for other than archiving purposes, is prohibited.
- Using the Town of Lewisville network to gain unauthorized access to any computer system is prohibited.
- The use of the Town of Lewisville's networks or devices owned, leased, maintained or otherwise controlled by the Town to access, view, transmit, store, display, or request obscene, pornographic, erotic, profane, racist, sexist, libelous, or other offensive or abusive material (including messages, images, video, or sound) is prohibited.

- The use of the Town of Lewisville Systems in such a way as to create an intimidating or hostile work environment is prohibited.
- Town of Lewisville Systems may not be used to solicit for personal gain or for the advancement of a political or religious belief.

VIII. Remote Access

Remote access to Town of Lewisville systems (access to the Town of Lewisville systems from external systems, e.g. via the Internet) consumes technology resources above and beyond those required for local access. The Town Manager will review written requests and grant remote access based upon business cases and resources available.

Remote access users are subject to all policies herein.

Additional security requirements may be established for remote access systems by the Town Manager or his/her designee.

IX. Hardware/Software Standards, Procurement, and Installation

The Town of Lewisville Town Manager or his/her designee has the sole responsibility for establishing standards, procuring, maintaining inventory, and installing technology required for Town operations. Information Technology is also responsible for engaging and managing relationships with technology vendors.

Employees who are not authorized to do so, are prohibited from procuring, and installing hardware or software for or on Town of Lewisville systems.

X. Electronic Messaging

Electronic messaging includes, but is not limited to email, instant messages, text messages, blog posts, forum posts, wiki posts, images and audio or video recordings. Electronic messaging may not be used in any way which violates Town policy.

A. Town Representation

All publicly posted electronic messages must clearly identify the user, with credentials assigned by the Town. Message subject and content must be in the interest of the Town.

B. Personal Messaging Accounts

Personal messaging accounts may not be accessed from Town systems. Information Technology staff may use personal messaging accounts solely for the purpose of testing Town of Lewisville systems.

C. Internal Broadcast Messages

Town of Lewisville employees may not send out broadcast (very wide reaching) messages within the Town without Town Management approval. Only broadcast messages that are Town business related, or a matter of community interest will be authorized.

D. Public Record and Retention

Electronic messages may be considered public record and as such are subject to public record retention rules.

XI. Town Internet Content

Public Internet content includes but is not limited to the main Town public web site and all content therein, other Town-owned websites which lie outside of the main Town website, and social sites representing the Town which are administered by the Town.

Town of Lewisville public Internet content is the responsibility of the Town of Lewisville's Communications Specialist, Town Manager, or his/her designee. The Communications Specialist and his/her designee(s) may edit and publish public web content on behalf of the Town.

The Communications Specialist, Town Manager, or his/her designee is responsible for establishing and publishing website standards. All website content must comply with the Town of Lewisville website standards (design, layout, etc.) as approved by the Communications Specialist, Town Manager or his/her designee.

The Communications Specialist must review web application design and layout for adherence to standards before application publication. As web application content is dynamic in nature, review of said content is not required.

Each department is solely responsible for the accuracy of the content of their respective web site(s) and/or pages.

Links to other websites are restricted to local, state, federal government, or local non-profit sites. Links to personal websites are not allowed. Information on events will be limited to those directly sponsored by Town of Lewisville.

XII. Phone

Town of Lewisville provides its staff with telephones for conducting official Town business. Town phone use should be restricted to official Town business purposes, except for emergency and important telephone communications, such as child care needs, medical appointments, and other critical communications. Reasonable, infrequent personal use of the Town's telephone systems by employees is permitted, but should not interfere or conflict with official Town business use.

Personal long-distance telephone calls should not be made, except on an emergency basis. Charges for any personal long distance calls must be reimbursed to the Town by staff.

XIII. Storage Media Recycling and Disposal

The purpose of this section is to ensure that all digital media is properly recycled or disposed of for reasons pertinent to data security, software license protection, and in compliance with environmental regulation.

If a hard disk, tape, CD, DVD, ZIP disk, diskette, or other storage device can be re-used, users should erase the existing data from the device and continue to use it, or make it available for someone else to use. If the digital media is unusable, or is no longer needed, it should be destroyed.

Un-recycled or unusable media must be completely erased using a disk sanitizer utility. If that is not possible, the media should be physically damaged in a manner to render it unreadable by any device.

XIV. Surplus

The Town of Lewisville Information Technology support staff has sole responsibility for disposition of surplus technology hardware and software. All unassigned, unallocated, or otherwise unneeded equipment or software must be returned to the Town.

Effective upon adoption by the Lewisville Town Council on November 14, 2024.



**RESOLUTION 2024-058 OF THE LEWISVILLE TOWN COUNCIL
AWARDING FALL ROADWAY MAINTENANCE CONTRACT**

WHEREAS, the Town of Lewisville has a pavement preservation system for town-maintained streets; and,

WHEREAS, the Town must protect its assets in a most fiscally, responsible manner; and,

WHEREAS, crack sealing of streets adds years to the life of streets before the street needs to be fully repaved; and,

WHEREAS, it has been determined that asphalt hot crack sealing and speed hump maintenance is needed for the Arbor Run/Oak Grove area; and,

WHEREAS, it has been determined that asphalt hot crack sealing is needed for the Sequoia, Shallowford Lakes, Wellesley Place and Ridgecrest areas; and,

WHEREAS, funds to complete the project are appropriated in the 2024-001 Budget Ordinance; and,

WHEREAS, American Spray Tech has bid the best price for this project.

NOW, THEREFORE BE IT RESOLVED THAT THE LEWISVILLE TOWN COUNCIL the Town Manager is authorized to award a contract to American Spray Tech for asphalt hot crack sealing and speed hump maintenance as specified for an amount not to exceed \$86,952.

Approved and effective this the 14th day of November 2024 by the Lewisville Town Council.

ATTEST:

Mike Horn, Mayor

Dora K. Moore, Town Clerk



**RESOLUTION 2024-043 OF THE LEWISVILLE TOWN COUNCIL
FACILITY FEE EXEMPTION FOR LEWISVILLE UNITED METHODIS CHURCH PRESCHOOL**

WHEREAS, a Facility Use Exemption Policy for parks and recreation facilities is outlined in Town Code Chapter 16-14; and,

WHEREAS, the Lewisville United Methodist Church Preschool has requested use of the HG Galloway Reynolds Community Center first floor and kitchen for a Christmas party for the preschool teachers on December 10, 2024, 5-9 PM.

NOW, THEREFORE BE IT RESOLVED, THAT THE LEWISVILLE TOWN COUNCIL approves a one-time facility user fee exemption per Town Code Chapter 16-14 for the Lewisville United Methodist Church Preschool to utilize the G Galloway Reynolds Community Center on December 10, 2024.

Adopted and effective this the 14th day of November 2024 by the Lewisville Town Council.

ATTEST:

Mike Horn, Mayor

Dora K. Moore, Town Clerk